









---

**Sam Houston State University**

**INTERIOR SIGN STANDARDS**

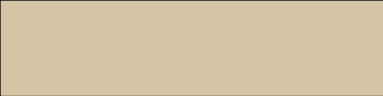
---

*v1. OCT 2012, rev. DEC 2012, Jan 2013*

	7725-10 White		7725-90 Antique White
	7725-121 Satin Aluminum		7725-49 Beige
	7725-31 Medium Gray		7725-89 Sandstone
	7725-187 Wedgewood Blue		7725-39 Tan
	7725-41 Dark Grey		7725-29 Russet Brown
	7725-17 Vivid Blue		7725-19 Deep Mahogany
	7725-197 Light Navy		7725-53 Cardinal Red
	7725-66 Forest Green		7725-14 Bright Orange

*Excerpt from Americans with Disabilities Act (ADA) Accessibility Guidelines (ADAAG). "Accessibility Guidelines for Buildings and Facilities"*

**4.30.5\* Finish and Contrast.** The characters and background of signs shall be eggshell, matte, or other non-glare finish. Characters and symbols shall contrast with their background -- either light characters on a dark background or dark characters on a light background.

**A4.30.5 Finish and Contrast.** An eggshell finish (11 to 19 degree gloss on 60 degree glossimeter) is recommended. Research indicates that signs are more legible for persons with low vision when characters contrast with their background by at least 70 percent. Contrast in percent shall be determined by:

$$\text{Contrast} = [(B1 - B2)/B1] \times 100$$



where B1 = light reflectance value (LRV) of the lighter area and B2 = light reflectance value (LRV) of the darker area.

Note that in any application both white and black are never absolute; thus, B1 never equals 100 and B2 is always greater than 0.

*The greatest readability is usually achieved through the use of light-colored characters or symbols on a dark background.*

1. *All interior signs are to be installed in accordance with current ADA regulations.*
2. *New ADA placement requirement:*  
As of March 2011, the new height requirement is a minimum of 48" to the bottom of the lower most tactile character and a maximum of 60" to the bottom of the upper most tactile character on the sign. Sign will be positioned 60" from the finished floor to the top of the sign. Side spacing is 2" from the frame on the latch side of the door. [additional detail on pg 01.C]
3. When you have space for the sign but less than 3" on each side, center the sign in the space. Sometimes it can be a problem to get a slider in if space is limited. In that case, the adhesive tab of one corner is left off so that corner can be lifted slightly to install the slider.
4. *Location of informational signs such as "NO FOOD OR DRINK":* These signs most often go under or to the side of room signs with a space of 1" between the two signs. These are usually wider signs and are installed after the fact. Line up the edge closest to the door if the sign is to go under. Line up the tops of the sign if the sign is to go to the side.
5. *Max Occupancy Signs:* These are required inside classrooms, auditoriums, cafeterias and other large rooms and are installed over the center of the door with a spacing of 1" from the door frame.
6. All 6" x 6" and 6" x 8" office signs will have name sliders for a uniform look. Some offices may have more than one occupant and require multiple name sliders. Office signs 6" x 8" are commonly used on for administrative positions such as Directors, Associate Directors, Department Chairs, Vice Presidents, Deans and other significant administrative offices. In this case it is acceptable, often preferred, that the administrator's personal preference be requested.
7. "NO SMOKING" signs are installed at the entrance to building. They are located on the lower portion of the door on the hinge side 28" to 32" from the finished floor.
8. *Exterior ADA building signs* will be fiberglass or comparable UV resistant material. [sign type is identified by the interior sign type moniker with the suffix 'Ex' to designate 'fabricate for exterior application'.]
9. Stairwell floor numbers go inside the stairwell and usually mount on the strike side of the door, 2 inches off the door frame and 60" to top of sign. The stairwell number signs go on the outside in the hallway and install like other ADA signs.
10. Signs that are mounted on glass windows beside the door always need a backplate for glass mounting to cover up the back side of the sign. These are made without borders and are the same background color as the sign they cover. [see pgs 01.10-01.11]
11. Offices and office areas that have a door not normally used for public entry should have signs that say "PLEASE USE OTHER DOOR OR ENTER THROUGH ROOM \_\_\_\_\_".
12. *All room identification signs must include the room number to meet Texas Higher Education Coordinating Board (THECB) standards.*
13. *\*Always visit the building before ordering signs to check area of placement, color, layout, and sizes of signs.*

Legend:

-  Copy\* and Raised Elements\*\*: Color 1
  -  Background and Braille\*\*\*: Color 2
  -  Insert: Color 1 or Color 3
- \*Copy on inserts are NOT raised elements  
\*\*Per ADA, Braille to match background color

\*\*\* Grade II Dome Braille is NOT translated herein, depictions are examples only, fabricator to ensure Grade II Dome Braille translations and ADA compliance

10.26.12 - rev00, cmc
12.14.12 - rev01, cmc
12.20.12 - rev01, cmc
01.08.13- rev02, cmc
01.14.13 - rev03, cmc

This drawing and the ideas expressed remain the confidential property of INNERFACE. This drawing and its ideas are not to be reproduced, copied, or disclosed to any other person or entity without the express written consent of a representative of INNERFACE.

# ADA Sign Placement Requirements

## Character Height

Minimum character height for ceiling or projecting wall mounted directional or informational signage is 2", provided that the sign is mounted no more than 10' high from the floor or ground surface.

5/8" minimum character height for all signs mounted between 40" and 70" from the floor or ground surface. This applies to all identification, informational, and directional signs. The 5/8" minimum does not apply to such regulatory signs as EMTALA, patients rights & responsibilities, marketing notices, etc. For specific instances, always contact the ADA hotline for clarification prior to manufacturing.

No sign shall be mounted lower than 40" from the floor or ground surface.

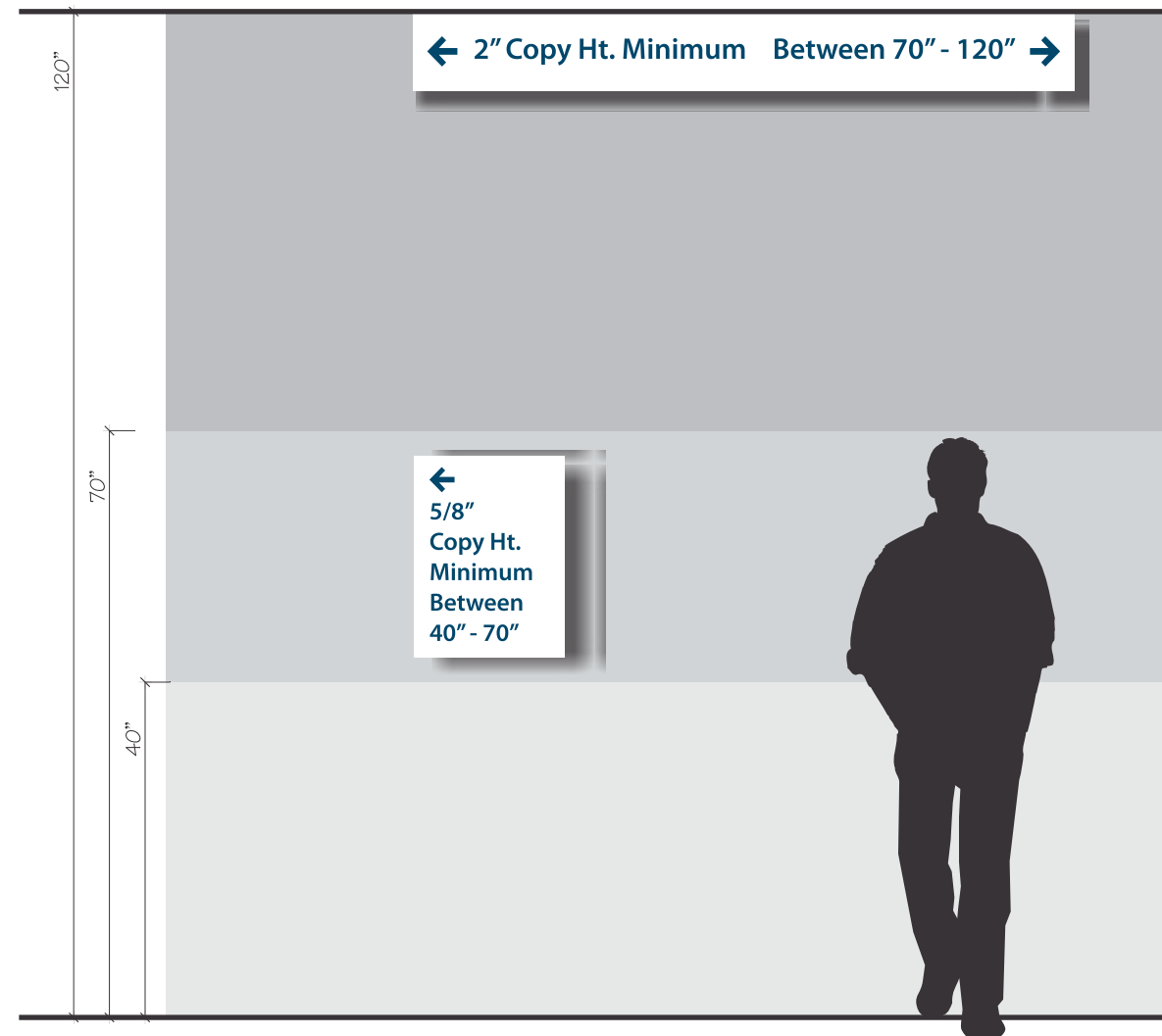

## Tactile Sign Mounting

Tactile signs are to be mounted on the latch side of the door, 2" from the door frame, 48" minimum, 60" maximum measured to the baseline of the raised characters.\*

\*NOTE: SHSU Standard Mounting for ADA signage is 60" grade to top of sign (unless doing so would cause Braille to not fall within 48"- 60" grade to baseline of Braille, thus contradicting ADA requirements)

18" of clear free space (CFS) must be maintained at the sign location.

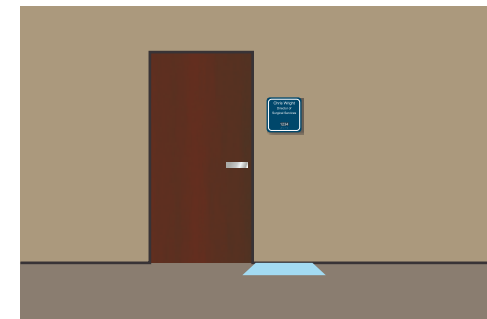
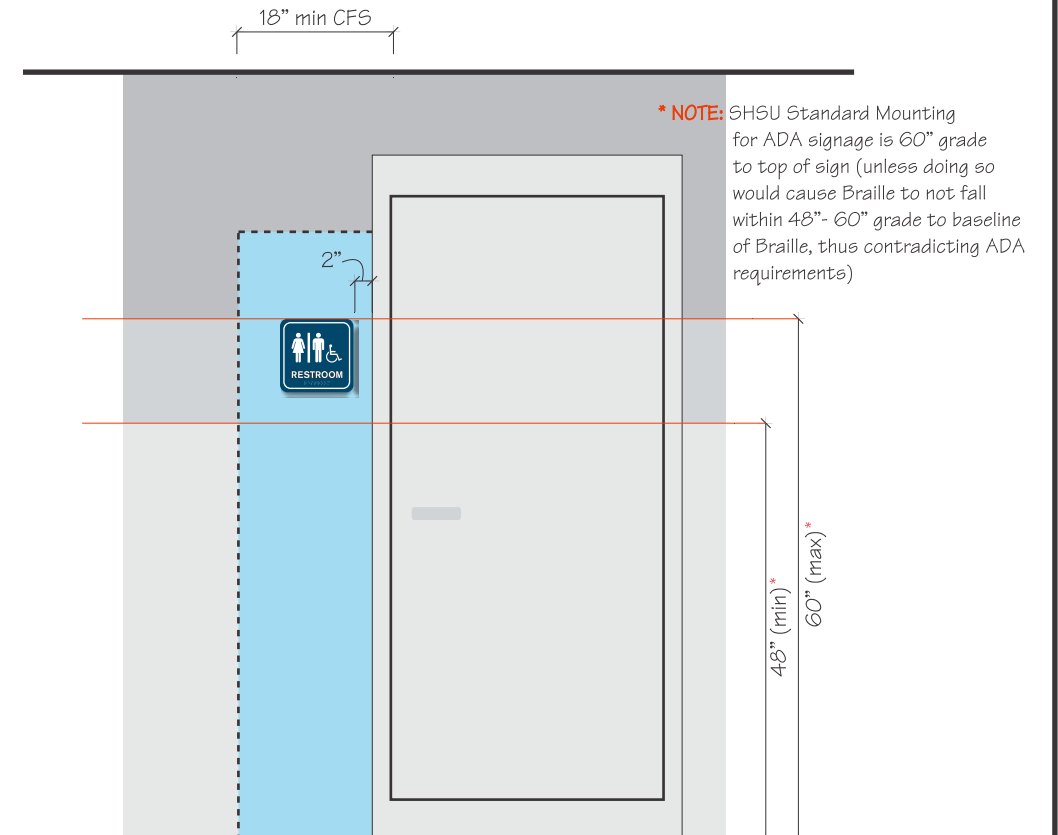
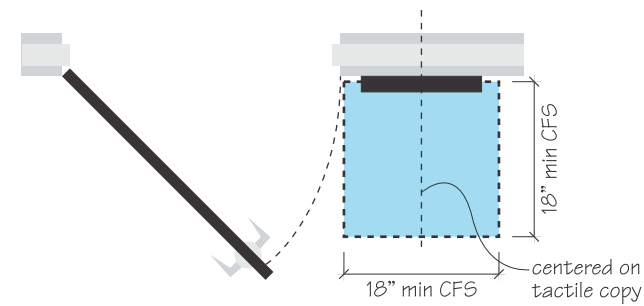

Ideal Location on Latch Side of Door

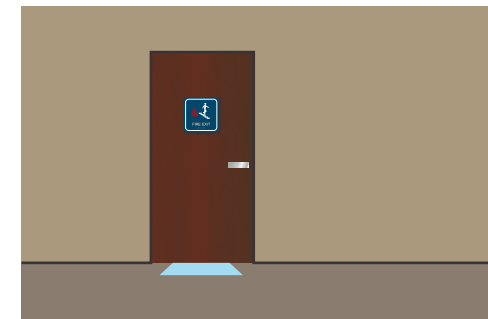

Located on Push Side of Door if Door Opens Inward and Does Not have a Hold-open Device

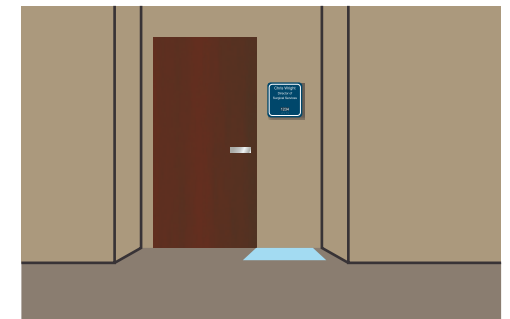

Inset door opening, then Nearest Adjacent Wall

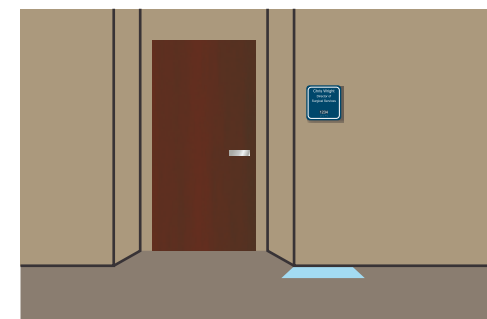

Inset door opening, No space on Latch Side

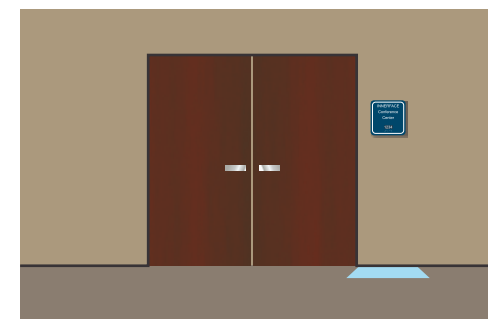

Double doors with 2 Active Leafs

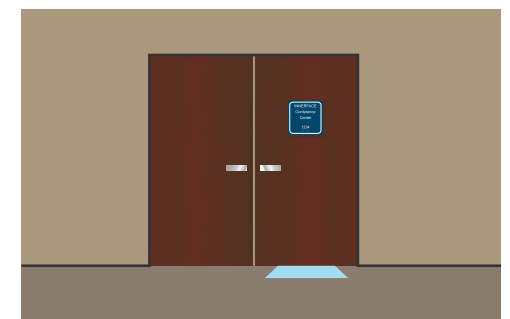

Double Doors with 1 Active Leaf

### Legend:

- Copy\* and Raised Elements\*\*: Color 1
- Background and Braille\*\*\*: Color 2
- Insert: Color 1 or Color 3

\*Copy on inserts are NOT raised elements  
\*\*Per ADA, Braille to match background color

\*\*\* Grade II Dome Braille is NOT translated herein, depictions are examples only, fabricator to ensure Grade II Dome Braille translations and ADA compliance

10.26.12 - rev00, cmc
12.14.12 - rev01, cmc
12.20.12 - rev01, cmc
01.08.13 - rev02, cmc
01.14.13 - rev03, cmc

This drawing and the ideas expressed remain the confidential property of INNERFACE. This drawing and its ideas are not to be reproduced, copied, or disclosed to any other person or entity without the express written consent of a representative of INNERFACE.



**A.1a ~ 3" X 6" ADA ROOM ID, NUMERICAL**

**A.1aEX ~ Single Layer Exterior Grade Fiberglass**

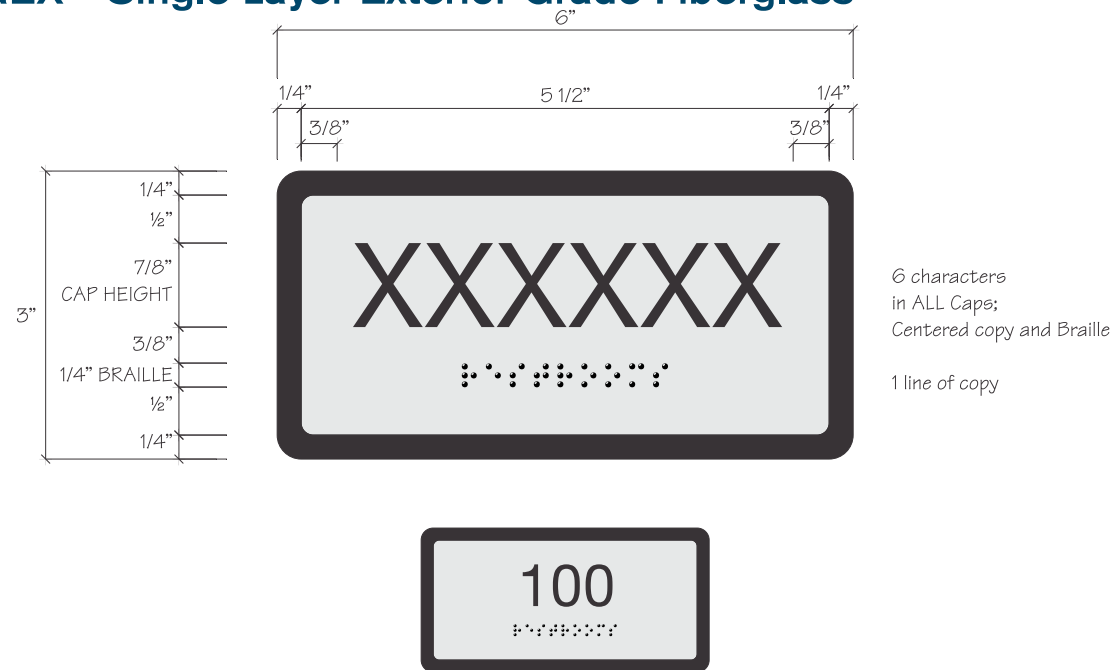

**A.1b ~ 3" X 6" NUMERICAL**

**A.1bEX ~ Single Layer Exterior Grade Fiberglass**

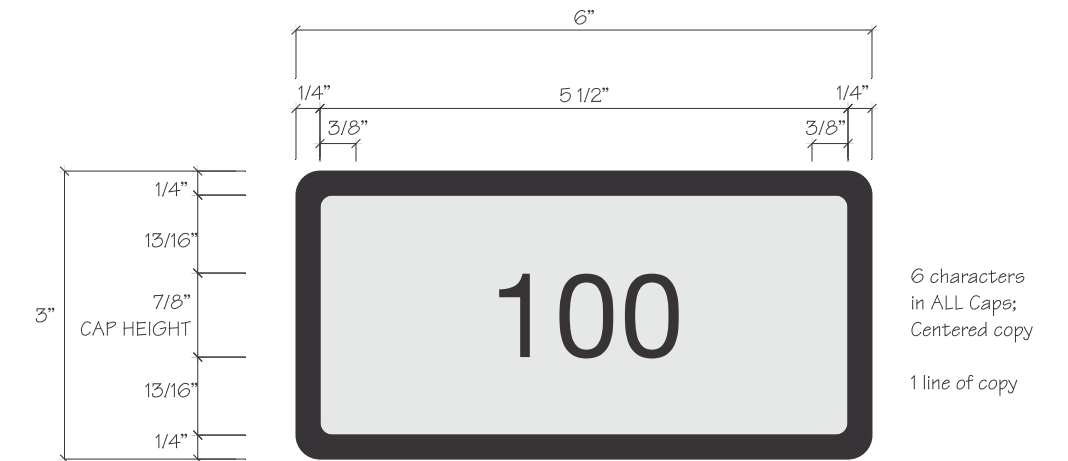

**A.2a ~ 3" X 6" ADA ROOM ID, COPY**

**A.2aEX ~ Single Layer Exterior Grade Fiberglass**

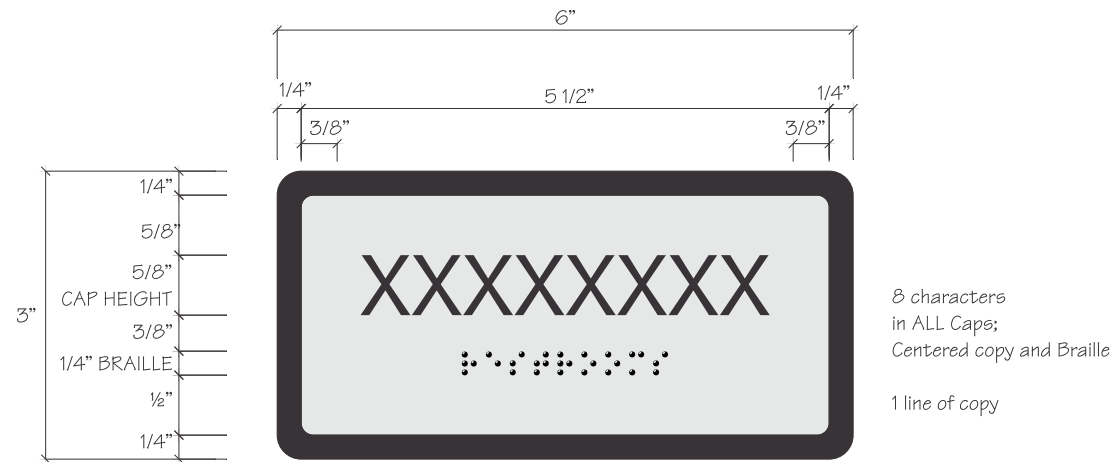

**A.2b ~ 3" X 6" COPY**

**A.2bEX ~ Single Layer Exterior Grade Fiberglass**

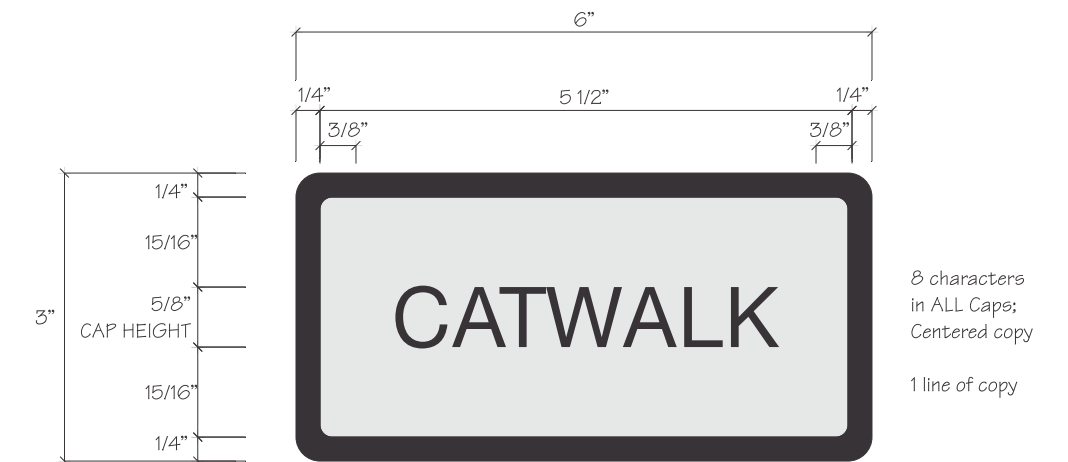

Legend:

- Copy\* and Raised Elements\*\*: Color 1
- Background and Braille\*\*\*: Color 2
- Insert: Color 1 or Color 3

\*Copy on inserts are NOT raised elements  
\*\*Per ADA, Braille to match background color

\*\*\* Grade II Dome Braille is NOT translated herein, depictions are examples only, fabricator to ensure Grade II Dome Braille translations and ADA compliance

10.26.12 - rev00, cmc
12.14.12 - rev01, cmc
12.20.12 - rev01, cmc
01.08.13 - rev02, cmc
01.14.13 - rev03, cmc

This drawing and the ideas expressed remain the confidential property of INNERFACE. This drawing and its ideas are not to be reproduced, copied, or disclosed to any other person or entity without the express written consent of a representative of INNERFACE.

**B.1 ~ 6" X 6" NUMERICAL**

**B.1EX ~ Single Layer Exterior Grade Fiberglass**

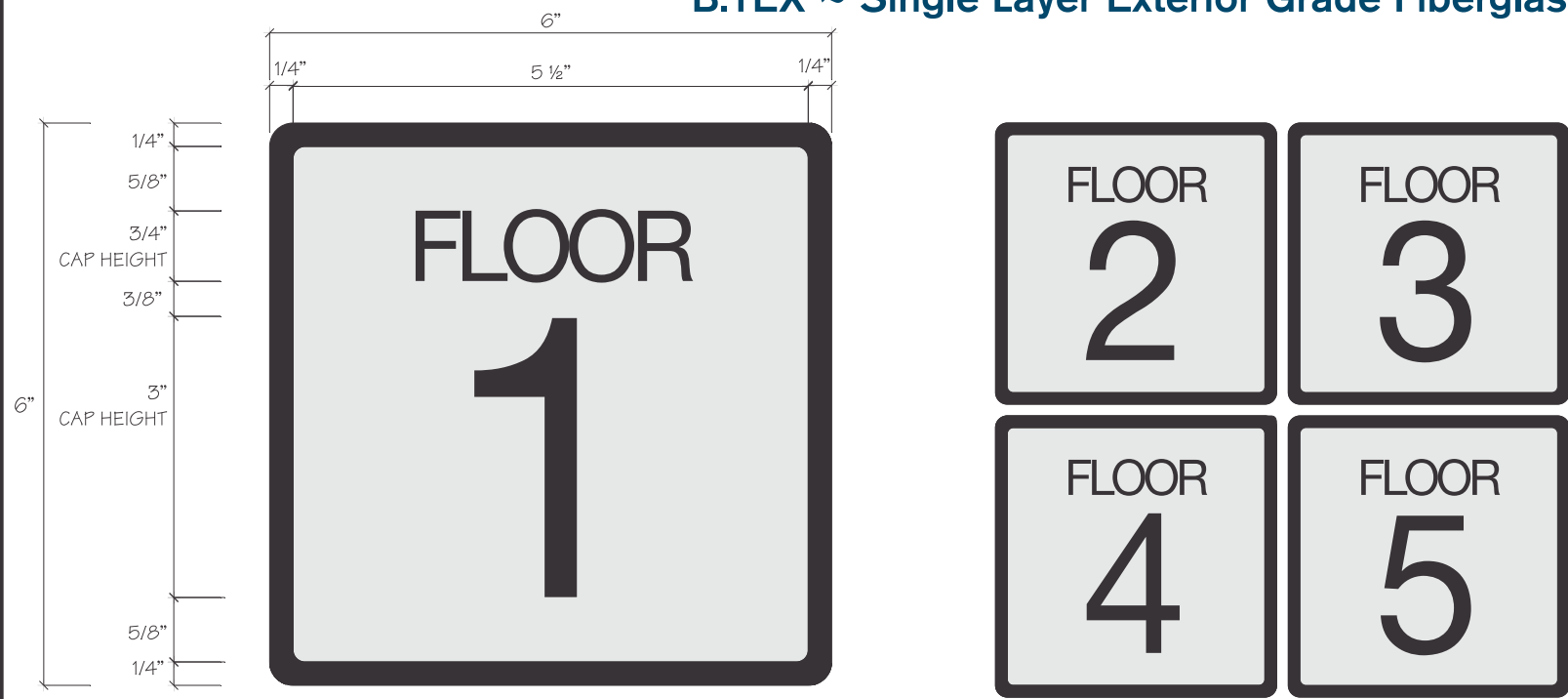

**B.3 ~ 6" X 6" ADA ROOM ID**

**B.2EX ~ Single Layer Exterior Grade Fiberglass**

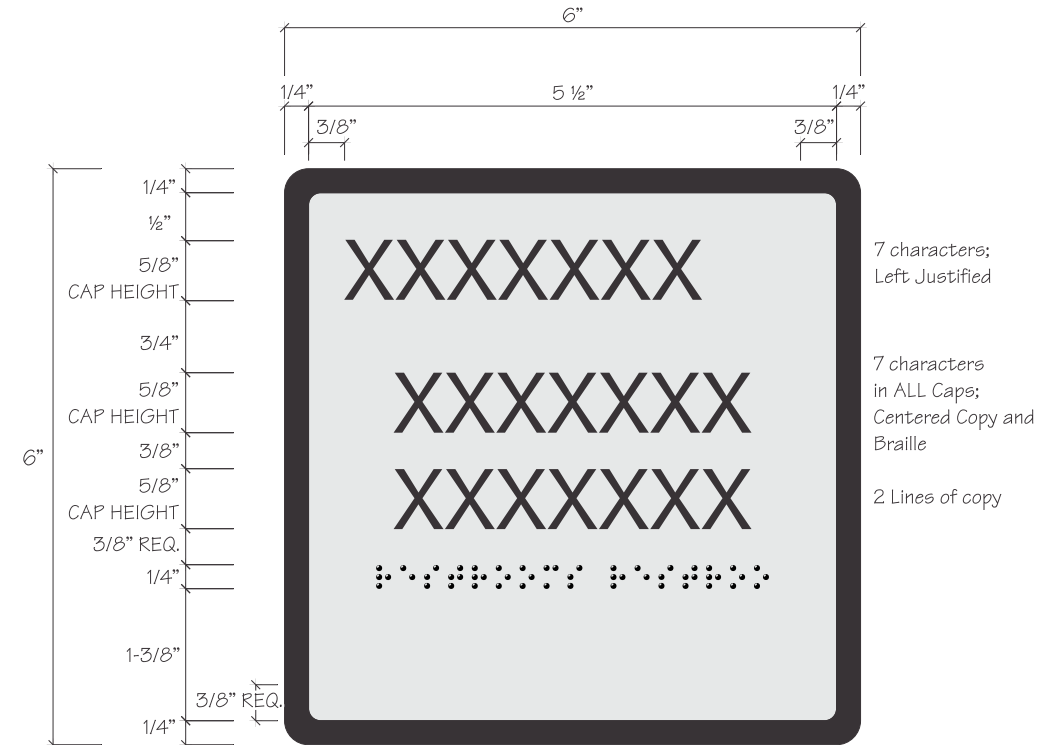

**B2 ~ 6" X 6" INFORMATIONAL**

**B.2EX ~ Single Layer Exterior Grade Fiberglass**

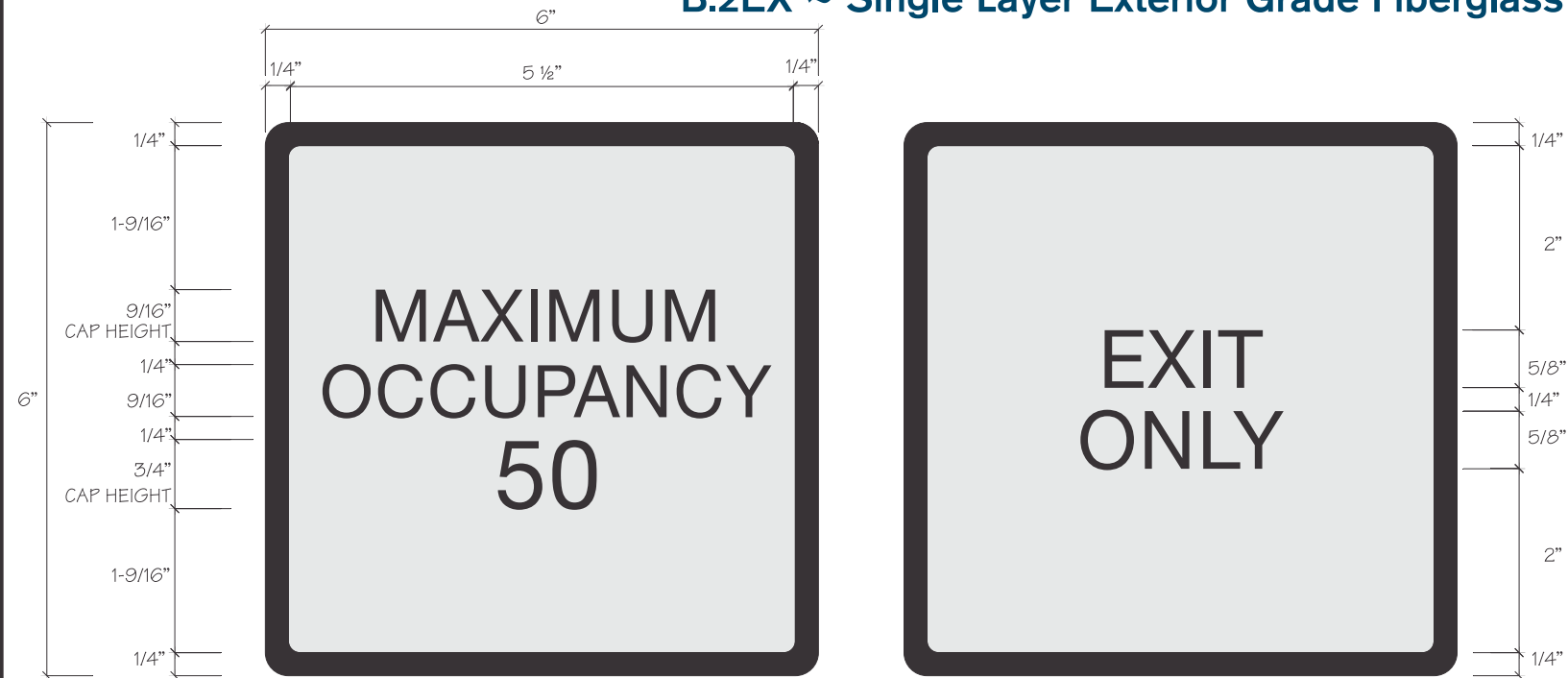

**C.1 ~ 6" X 6" ADA OFFICE ID W/ 1 INSERT**

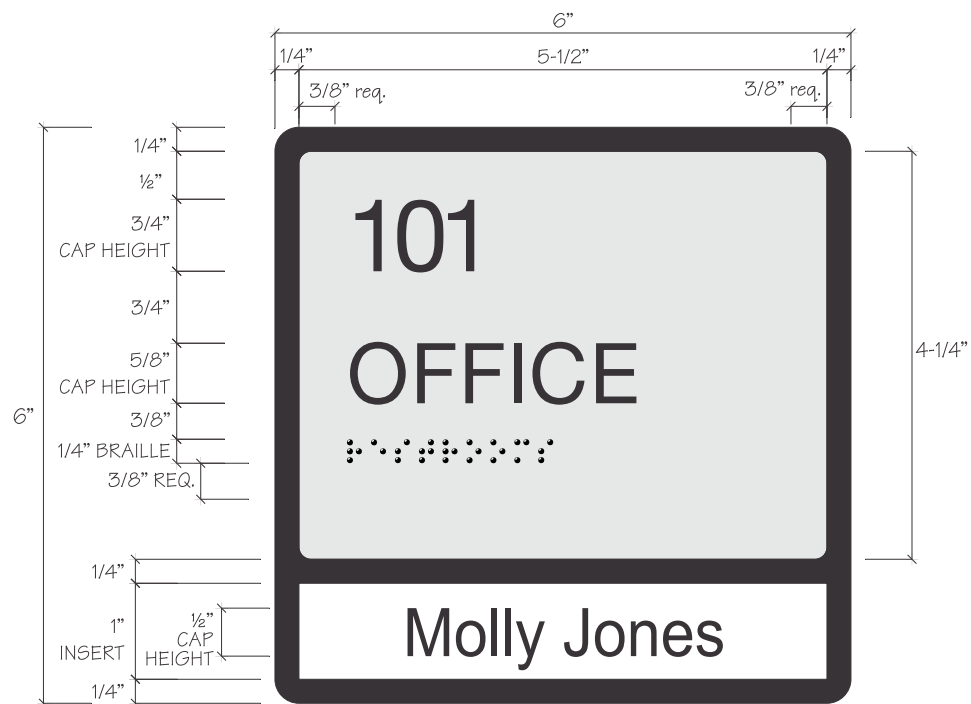

**C.3 ~ 6" X 6" ADA OFFICE ID W/ 3 INSERTS**

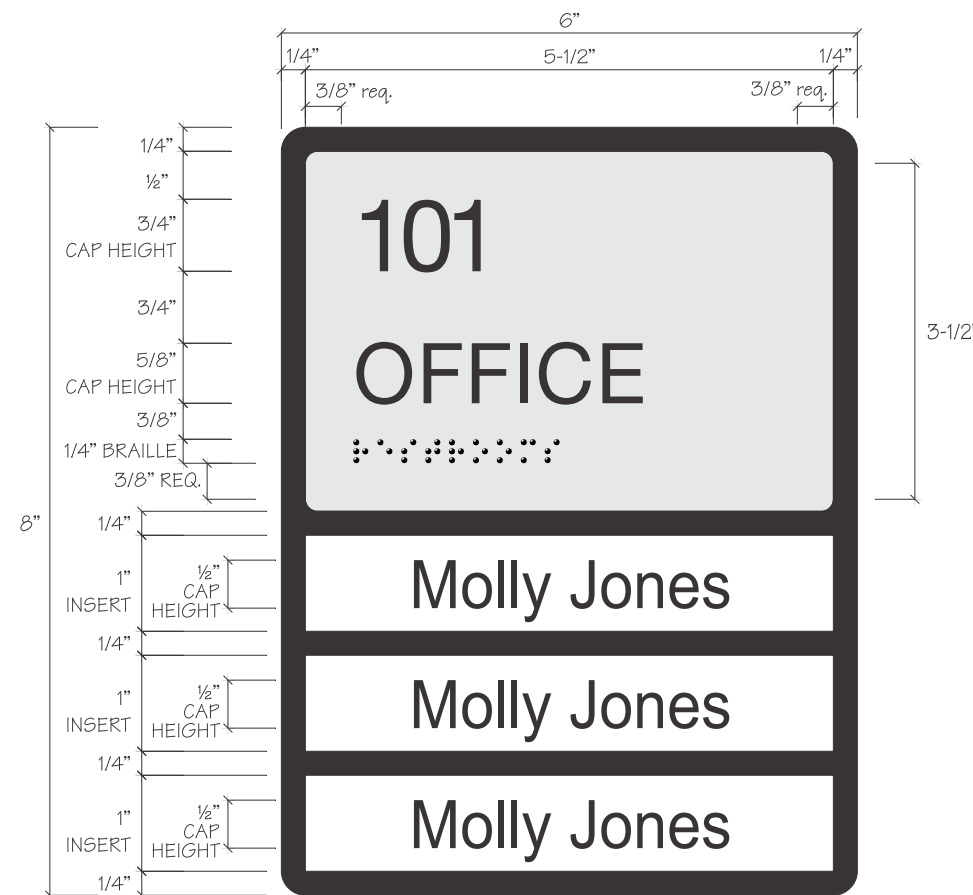

**C.4 ~ 6" X 6" ADA OFFICE ID W/ 4 INSERTS**

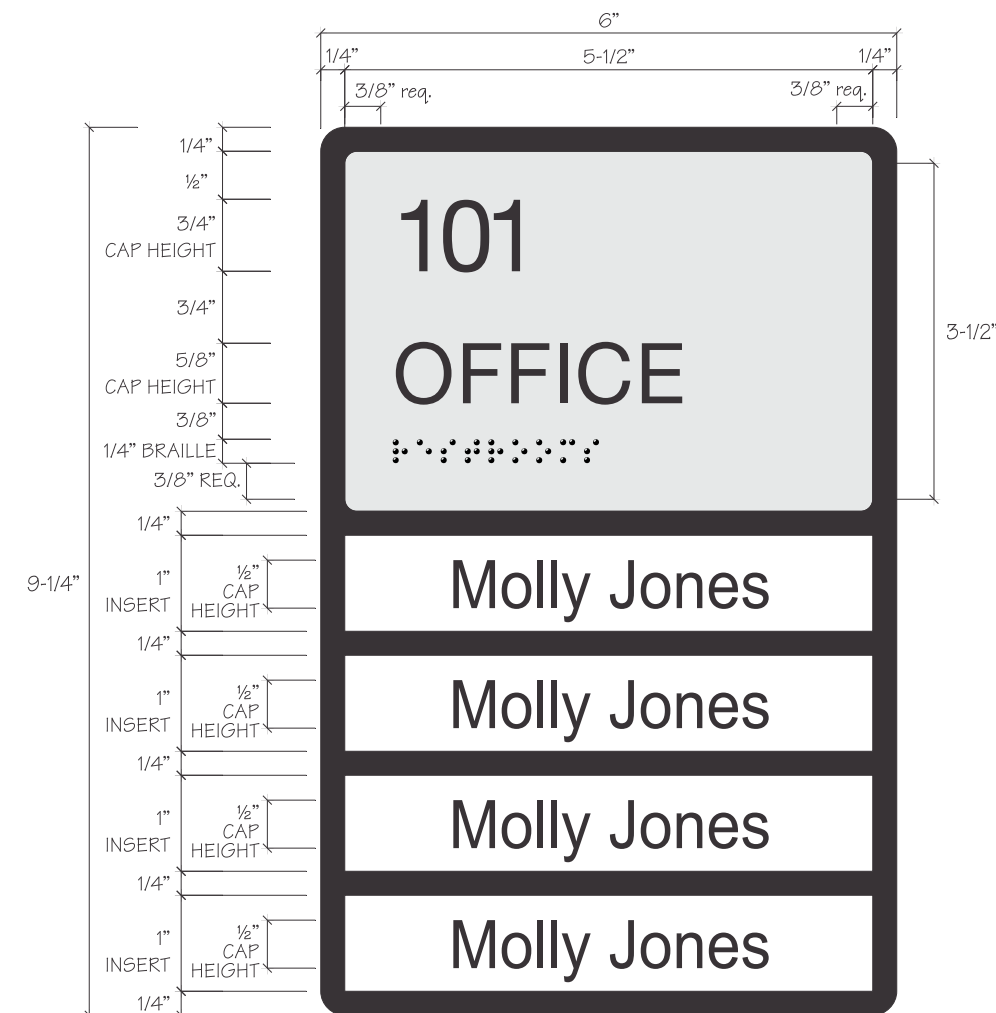

**C2 ~ 6" X 6" ADA OFFICE ID W/ 2 INSERTS**

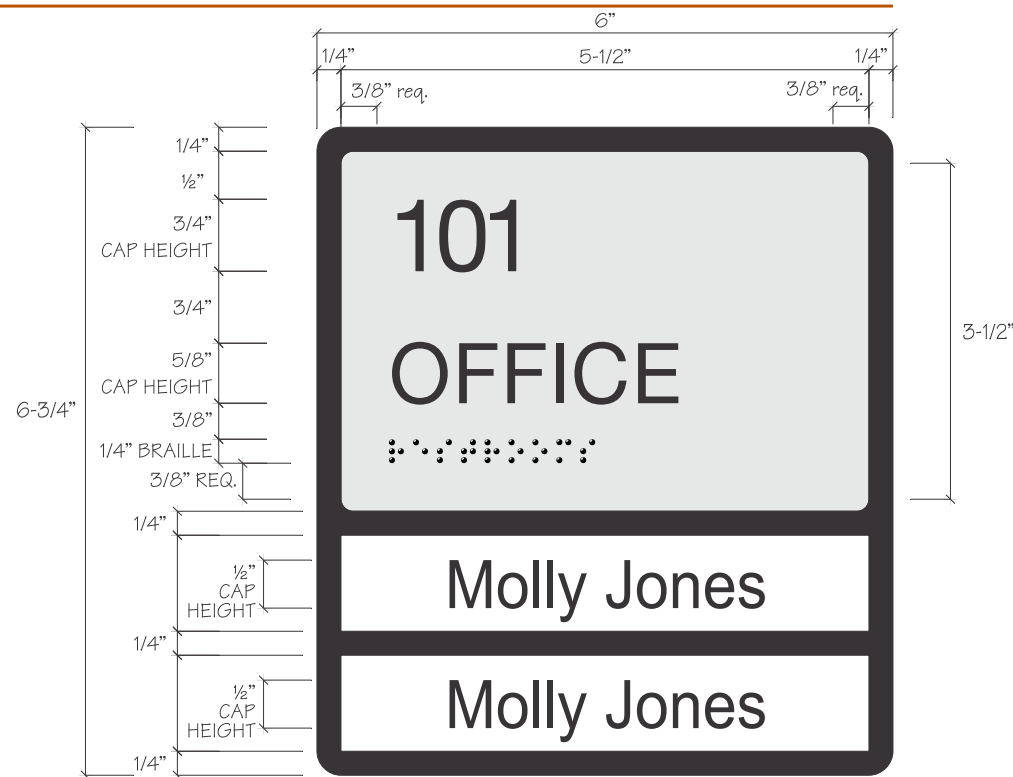

**C.1a ~ 1-1/2" X 6" ADD ON INSERTS**

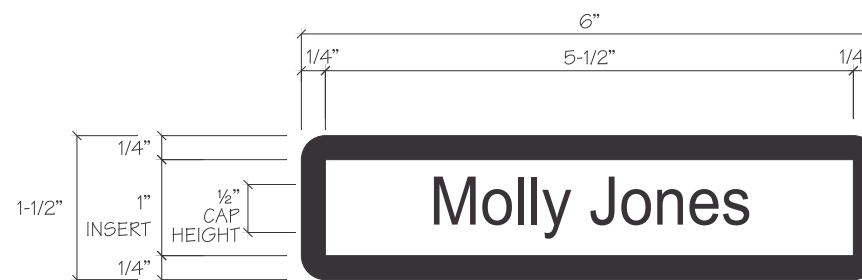

**D.0 ~ 6" X 8" ADA ROOM ID**

**D.0EX ~ Single Layer Exterior Grade Fiberglass**

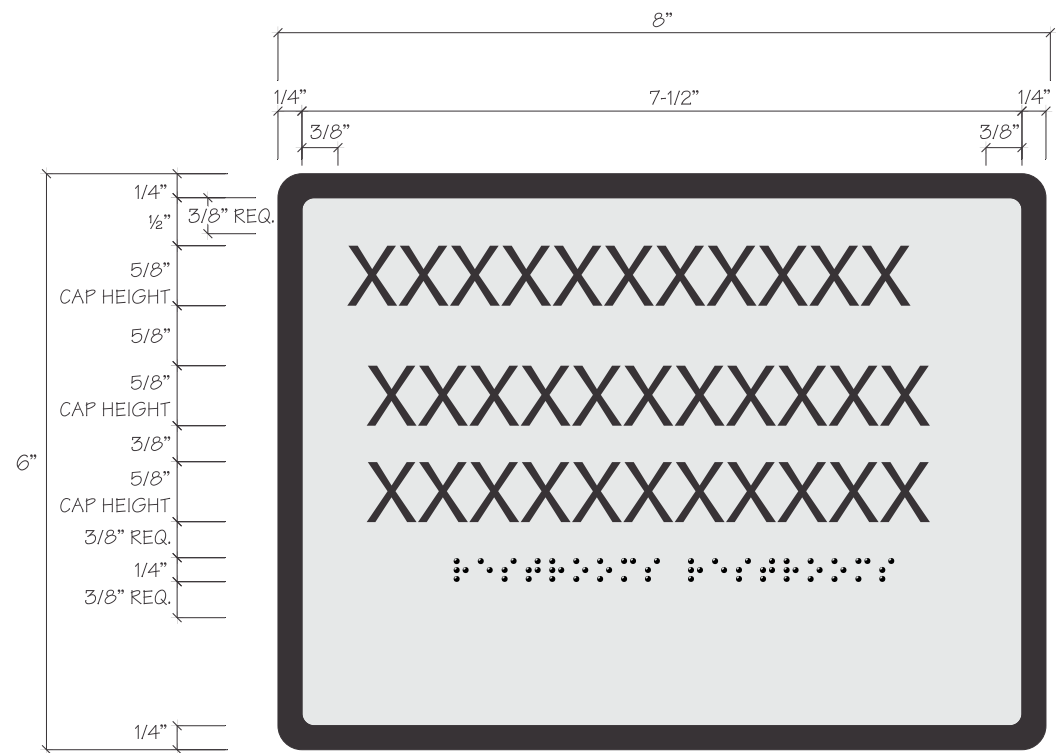

11 characters;  
Left Justified Copy

11 characters  
in ALL Caps;  
Centered copy and Braille

2 Lines of copy

**D.1 ~ 6" X 8" ADA ROOM ID W/ 1 INSERT**

**D.1EX ~ Single Layer Exterior Grade Fiberglass**

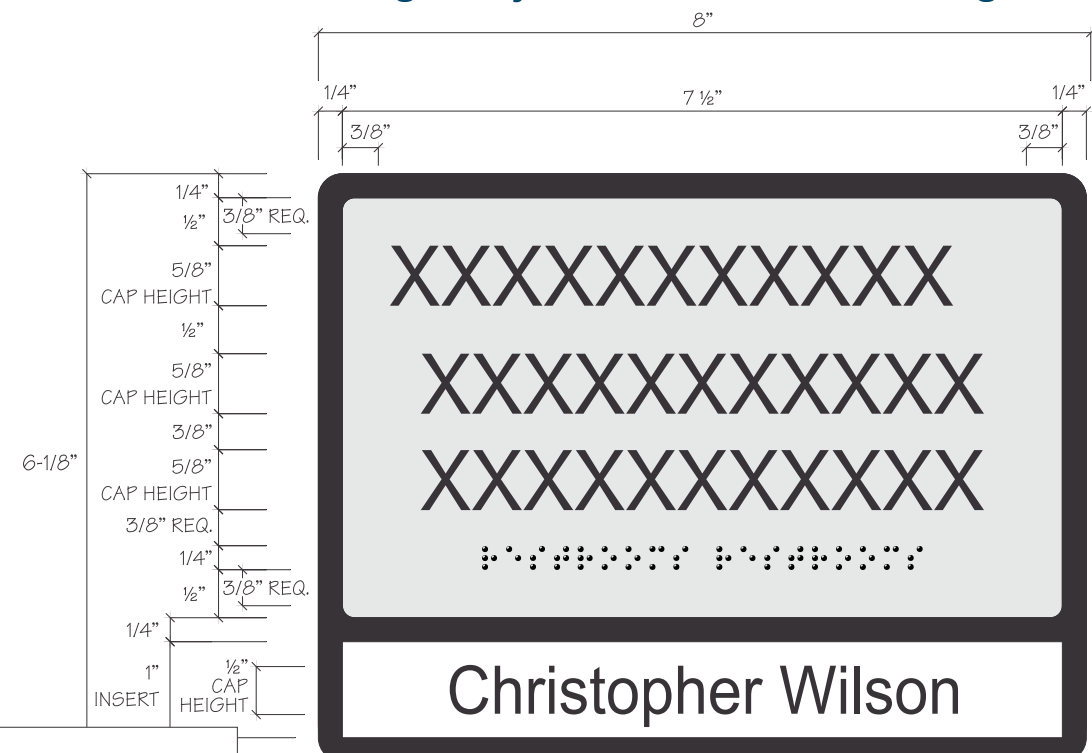

11 characters;  
Left Justified Copy

11 characters  
in ALL Caps;  
Centered copy and Braille

2 Lines of copy

Molly Jones

190  
DEANS SUITE  
⠠⠠⠠⠠⠠⠠⠠⠠⠠⠠⠠⠠⠠⠠⠠⠠⠠⠠

140  
STORAGE  
⠠⠠⠠⠠⠠⠠⠠⠠⠠⠠⠠⠠⠠⠠⠠⠠⠠

100U1  
ELECTRICAL  
⠠⠠⠠⠠⠠⠠⠠⠠⠠⠠⠠⠠⠠⠠⠠⠠⠠

187  
SUPERVISOR  
⠠⠠⠠⠠⠠⠠⠠⠠⠠⠠⠠⠠⠠⠠⠠⠠⠠

Christopher Wilson

185  
DEPARTMENT  
CHAIR  
⠠⠠⠠⠠⠠⠠⠠⠠⠠⠠⠠⠠⠠⠠⠠⠠⠠

Christopher Wilson

137  
LIGHTING  
STORAGE  
⠠⠠⠠⠠⠠⠠⠠⠠⠠⠠⠠⠠⠠⠠⠠⠠⠠

130  
CLASSROOM  
⠠⠠⠠⠠⠠⠠⠠⠠⠠⠠⠠⠠⠠⠠⠠⠠⠠

103U2  
MECHANICAL  
⠠⠠⠠⠠⠠⠠⠠⠠⠠⠠⠠⠠⠠⠠⠠⠠⠠

## E ~ 6" X 10" ADA ROOM ID

### E.EX ~ Single Layer Exterior Grade Fiberglass

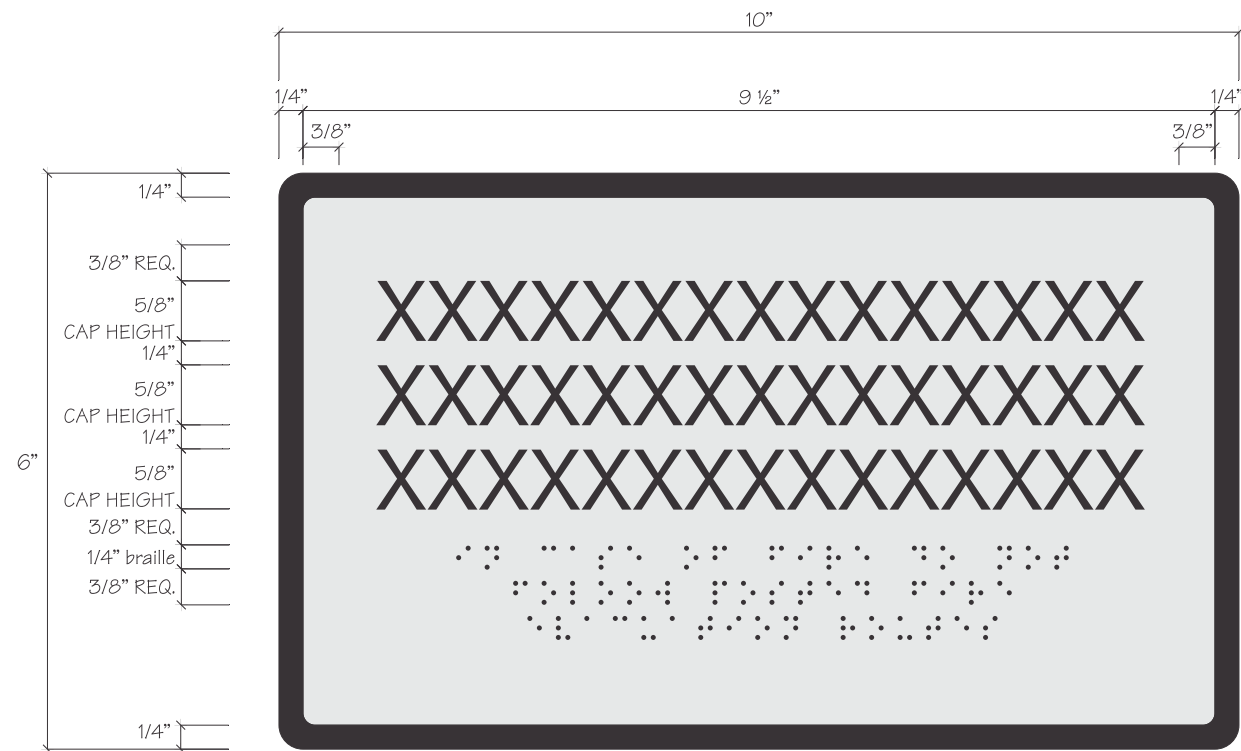

15 characters;  
Centered copy and Braille

3 lines of copy;

3 lines of braille



Legend:

- Copy\* and Raised Elements\*\*: Color 1
  - Background and Braille\*\*\*: Color 2
  - Insert: Color 1 or Color 3
- \*Copy on inserts are NOT raised elements  
\*\*Per ADA, Braille to match background color

\*\*\* Grade II Dome Braille is NOT translated herein, depictions are examples only, fabricator to ensure Grade II Dome Braille translations and ADA compliance

10.26.12 - rev00, cmc
12.14.12 - rev01, cmc
12.20.12 - rev01, cmc
01.08.13- rev02, cmc
01.14.13 - rev03, cmc

This drawing and the ideas expressed remain the confidential property of INNERFACE. This drawing and its ideas are not to be reproduced, copied, or disclosed to any other person or entity without the express written consent of a representative of INNERFACE.

**F.1 ~ 8" X 8" ADA INFORMATIONAL**

**F.1EX ~ Single Layer Exterior Grade Fiberglass**



**F.2 ~ 6" X 8" INFORMATIONAL**

**F.2EX ~ Single Layer Exterior Grade Fiberglass**



**F.3 ~ 4" X 6" INFORMATIONAL**

**F.3EX ~ Single Layer Exterior Grade Fiberglass**

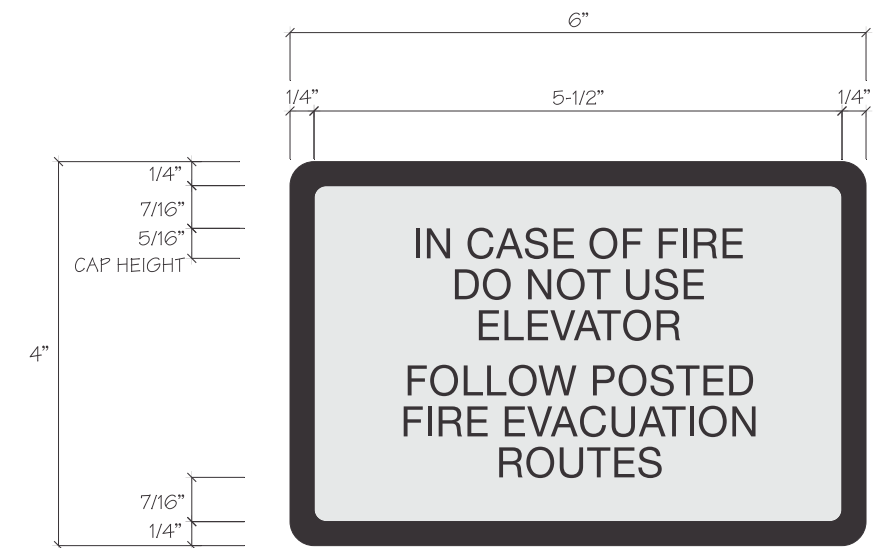

Legend:

- Copy\* and Raised Elements\*\*: Color 1
- Background and Braille\*\*\*: Color 2
- Insert: Color 1 or Color 3

\*Copy on inserts are NOT raised elements  
\*\*Per ADA, Braille to match background color

\*\*\* Grade II Dome Braille is NOT translated herein, depictions are examples only, fabricator to ensure Grade II Dome Braille translations and ADA compliance

10.26.12 - rev00, cmc
12.14.12 - rev01, cmc
12.20.12 - rev01, cmc
01.08.13 - rev02, cmc
01.14.13 - rev03, cmc

This drawing and the ideas expressed remain the confidential property of INNERFACE. This drawing and its ideas are not to be reproduced, copied, or disclosed to any other person or entity without the express written consent of a representative of INNERFACE.



**G.0 SM ~ 4" X 6" INFORMATIONAL SIGANGE**  
**G.0EX ~ Single Layer Exterior Grade Fiberglass**



**G.1 horiz. ~ tbd" X 10" INFORMATIONAL SIGANGE**  
**G.1EX ~ Single Layer Exterior Grade Fiberglass**

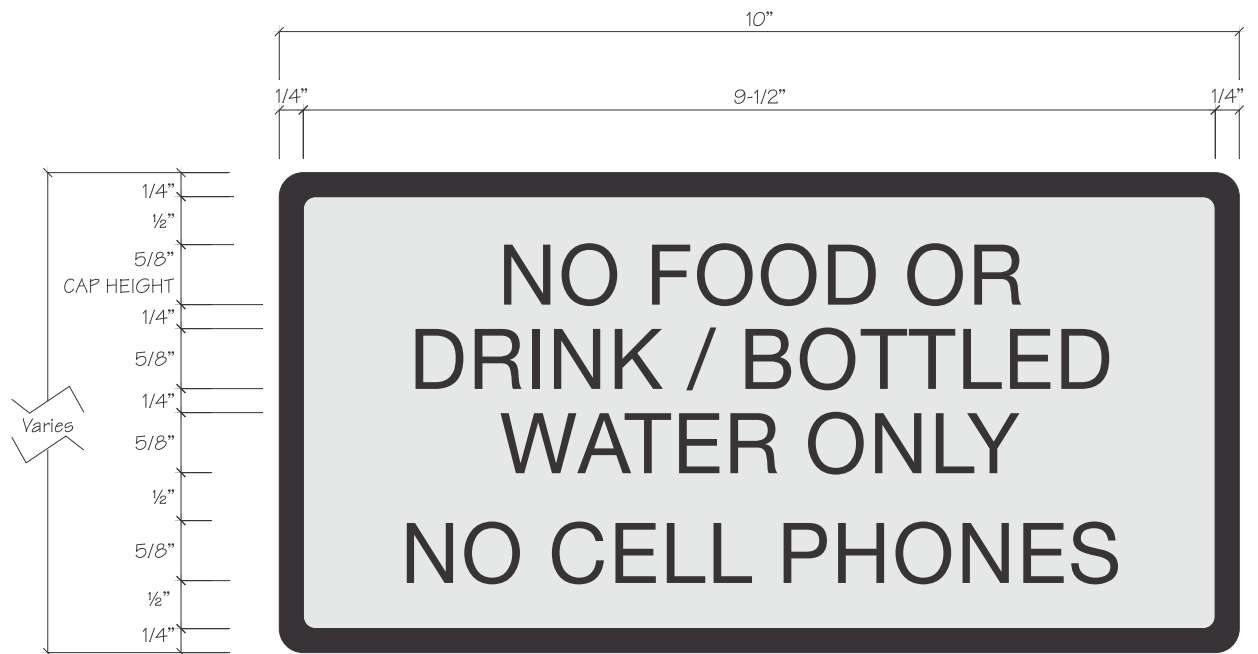

**G.2 vert. ~ tbd" X 10" INFORMATIONAL SIGANGE**  
**G.2EX ~ Single Layer Exterior Grade Fiberglass**



H.(et al) ~9 1/4" X 6 1/2" ADA ROOM ID w/ symbol

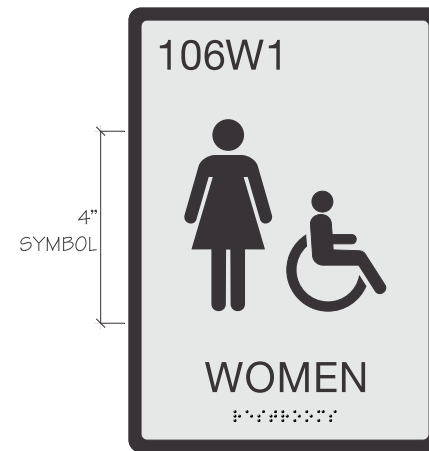
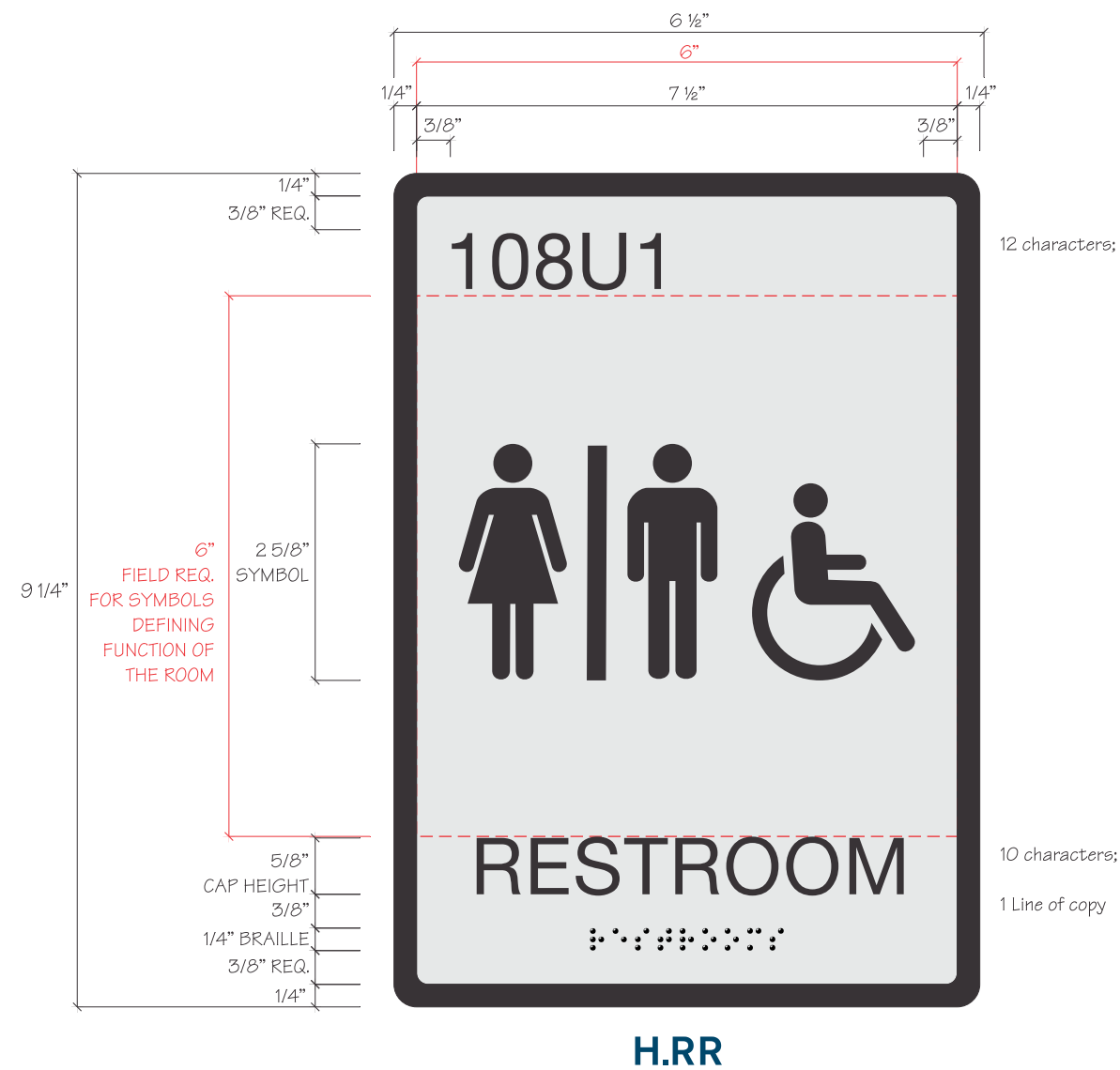

H.W

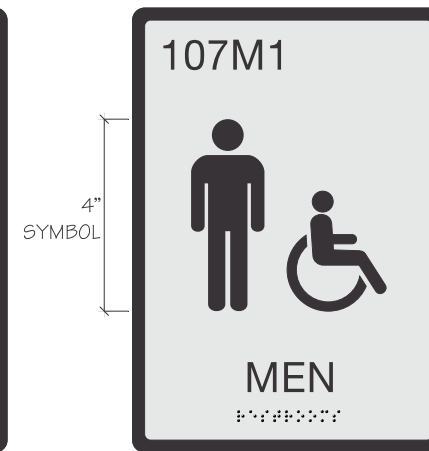

H.M



H.FS

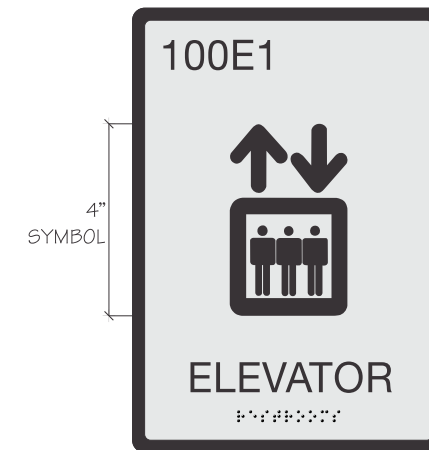

H.E

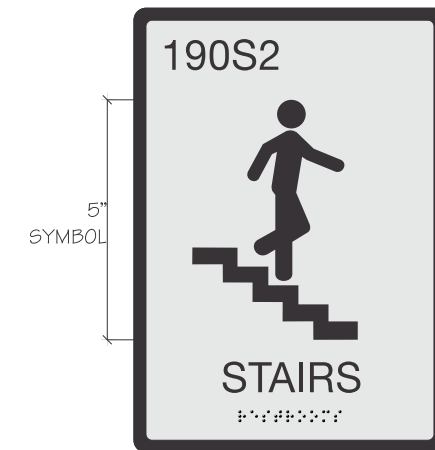

H.SS

Legend:

- Copy\* and Raised Elements\*\*: Color 1
- Background and Braille\*\*\*: Color 2
- Insert: Color 1 or Color 3

\*Copy on inserts are NOT raised elements  
 \*\*Per ADA, Braille to match background color

\*\*\* Grade II Dome Braille is NOT translated herein, depictions are examples only, fabricator to ensure Grade II Dome Braille translations and ADA compliance

10.26.12 - rev00, cmc
12.14.12 - rev01, cmc
12.20.12 - rev01, cmc
01.08.13- rev02, cmc
01.14.13 - rev03, cmc

This drawing and the ideas expressed remain the confidential property of INNERFACE. This drawing and its ideas are not to be reproduced, copied, or disclosed to any other person or entity without the express written consent of a representative of INNERFACE.

J.(et al) ~ tbd" x 12" DIRECTIONALS

J.(et al).EX ~ Single Layer Exterior Grade Fiberglass

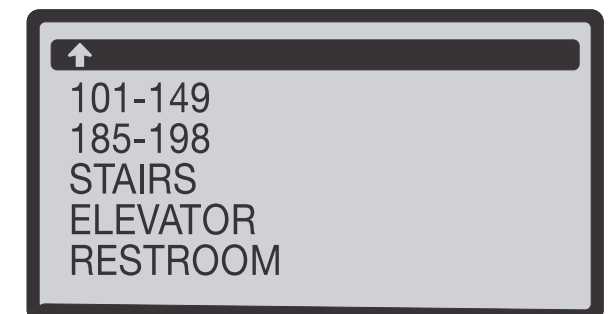
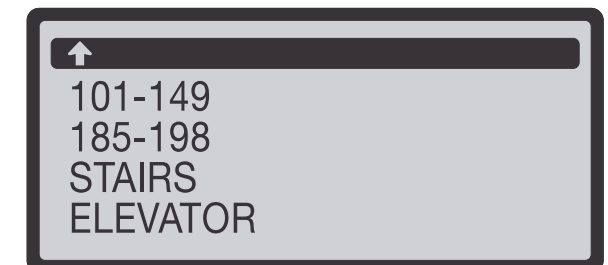
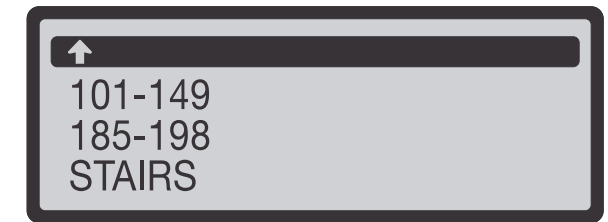
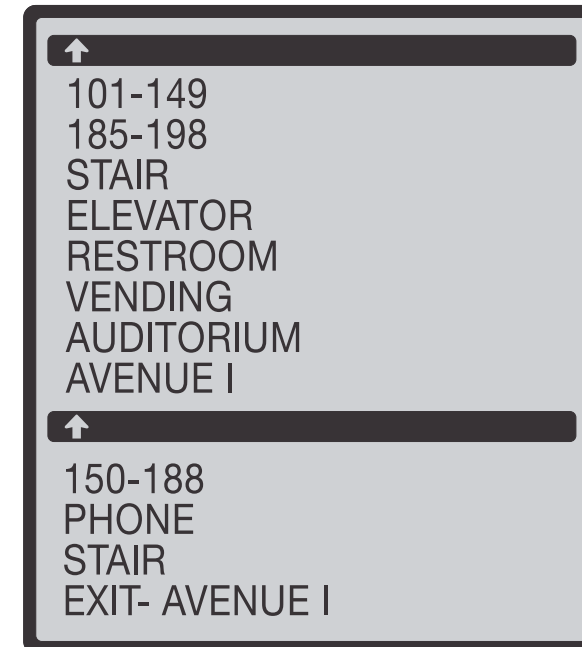
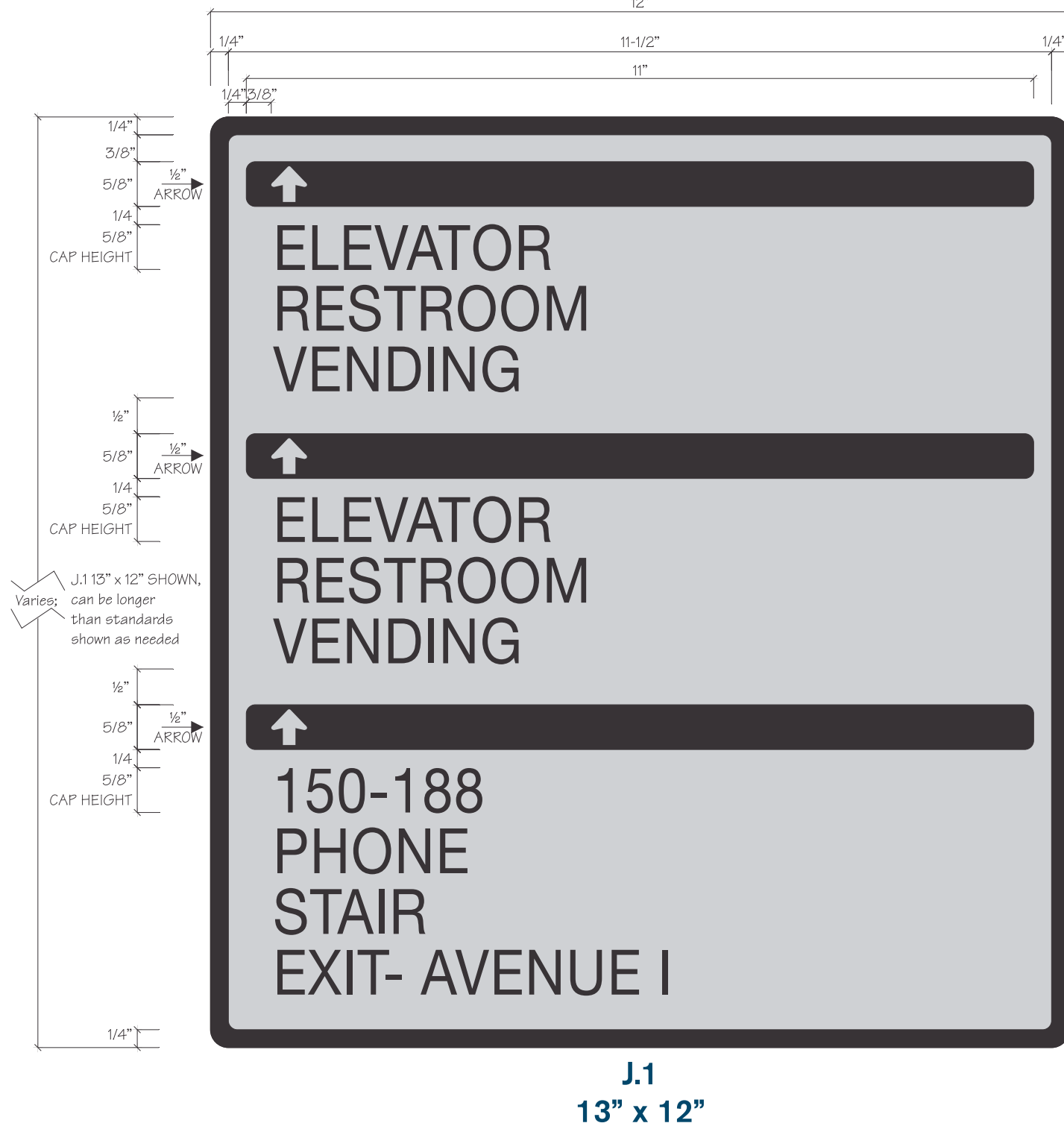

**BPG\* A.1a, A.1b, A.2a, A.26**

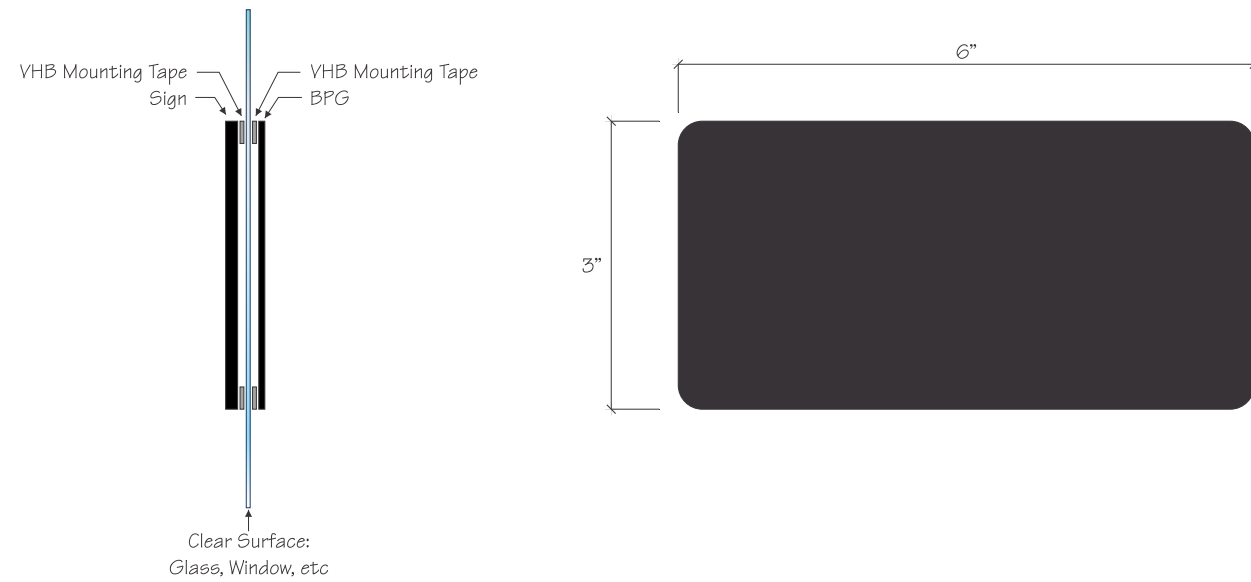

**BPG\* B.1, B.2, B.3, C.1**

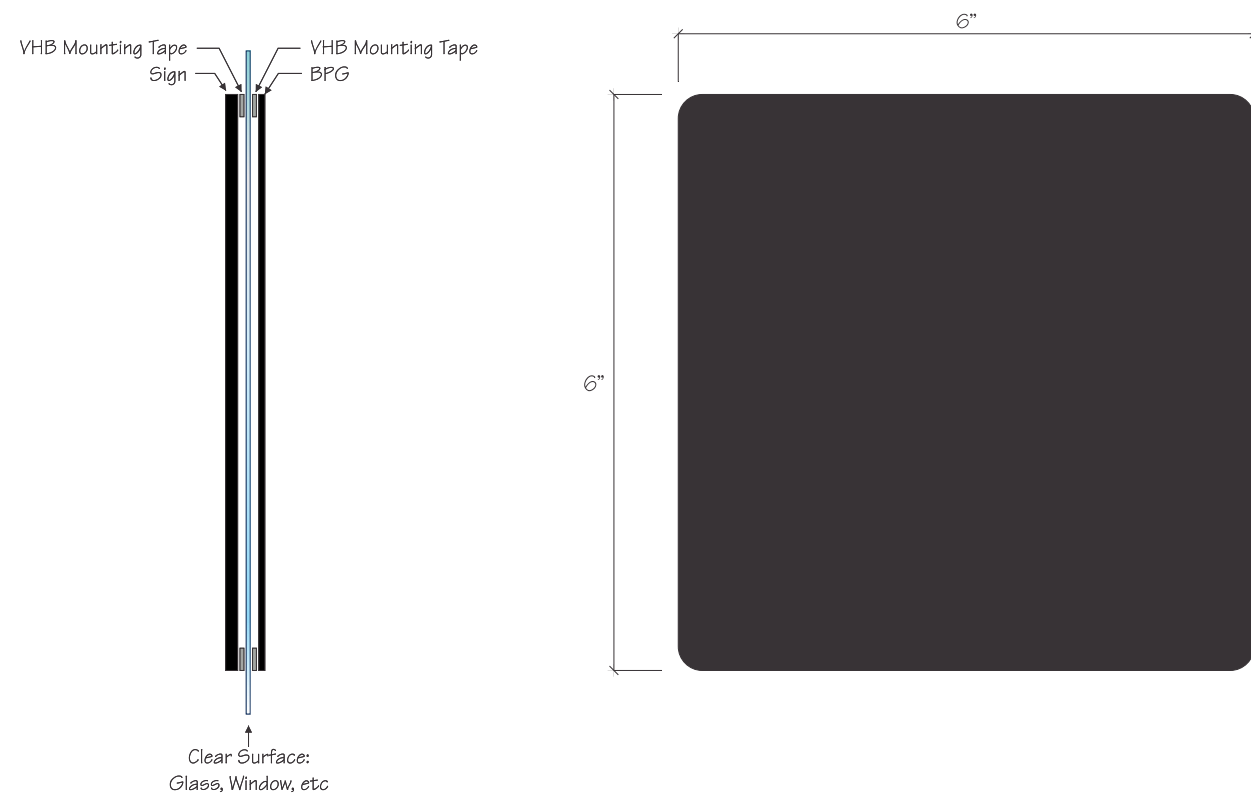

**\*BPG= Backplate For Glass/Window Mounting, applied to opposite side of clear surface from sign mounting to conceal mounting method.**

**BPG\* D.0, D.1**

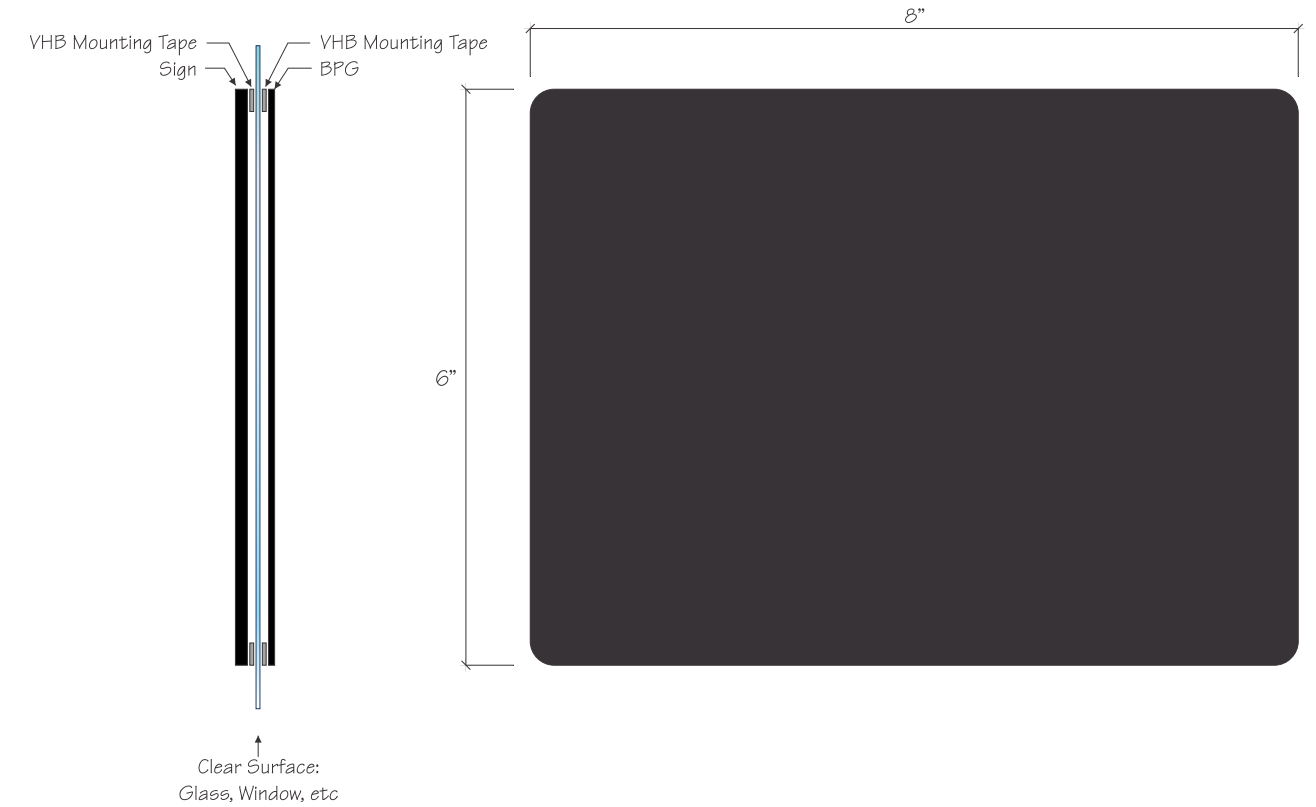

**BPG\* E**

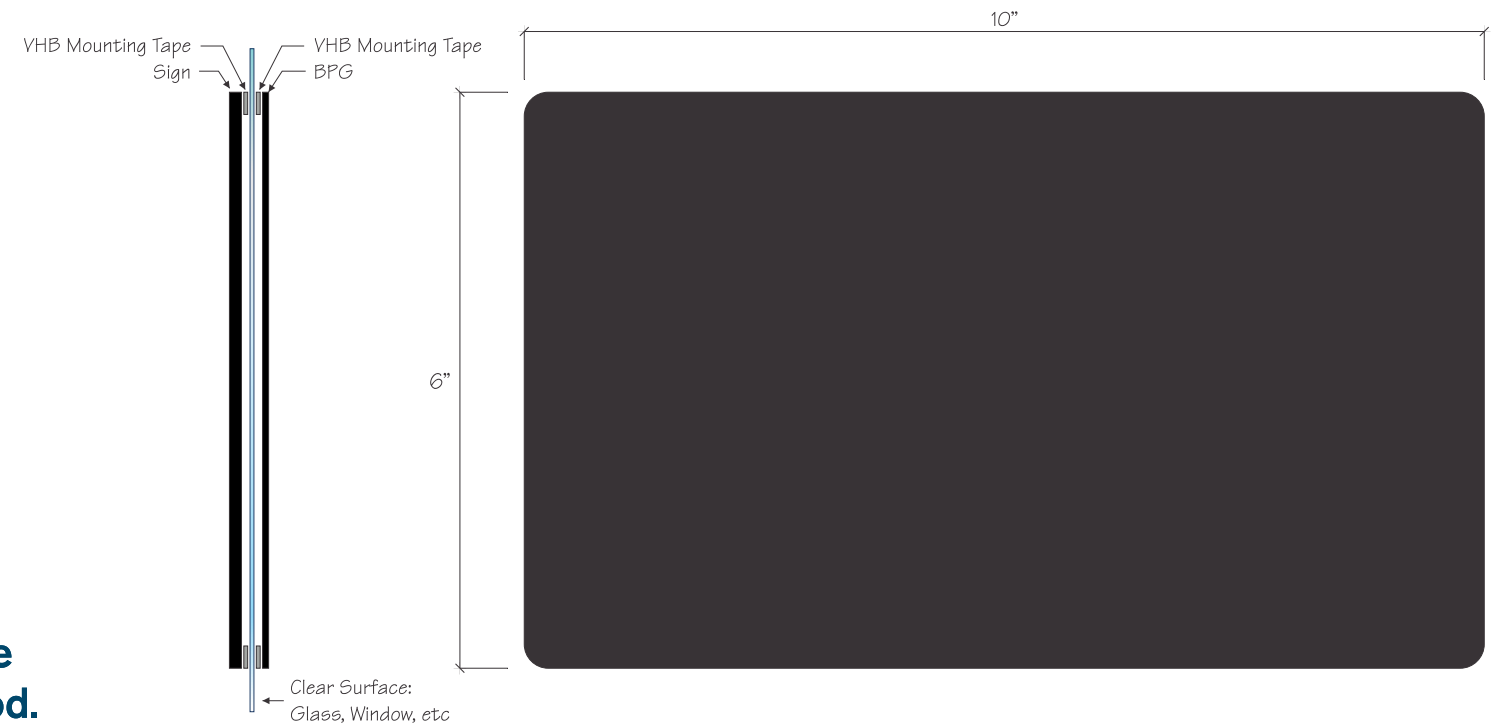

**BPG\* C.2**

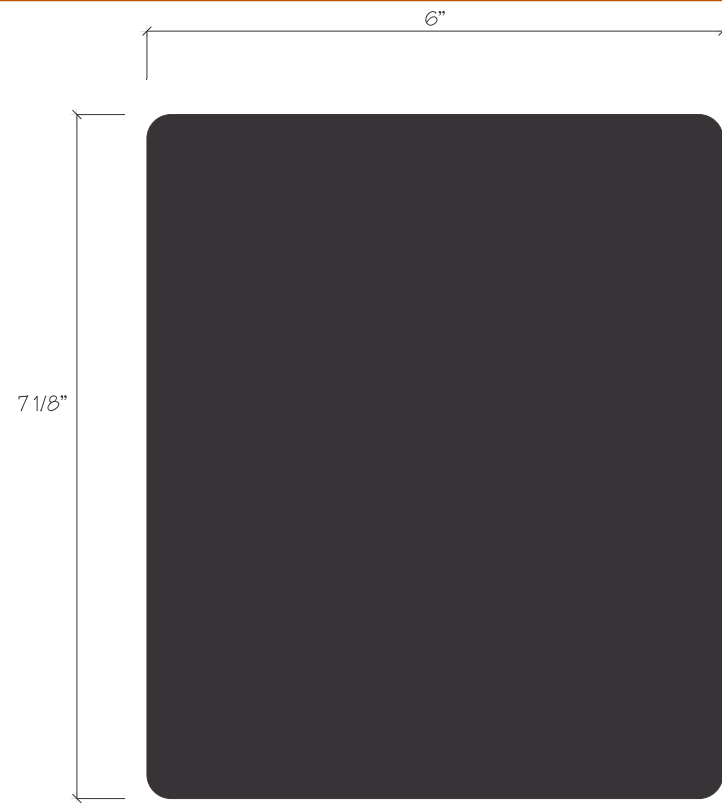

**BPG\* C.3**

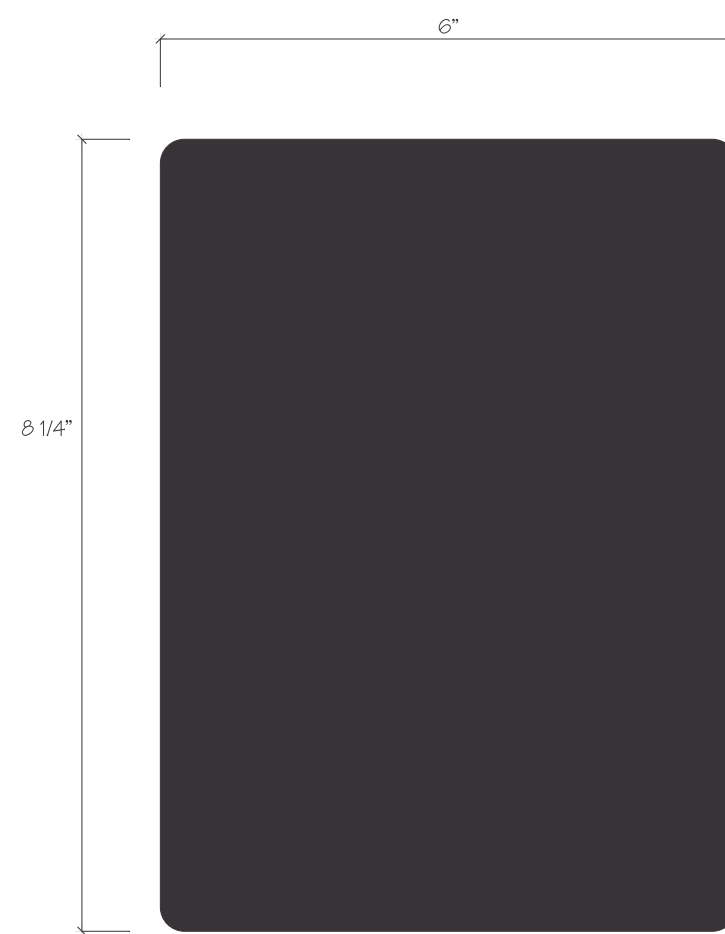

**BPG\* C.4**

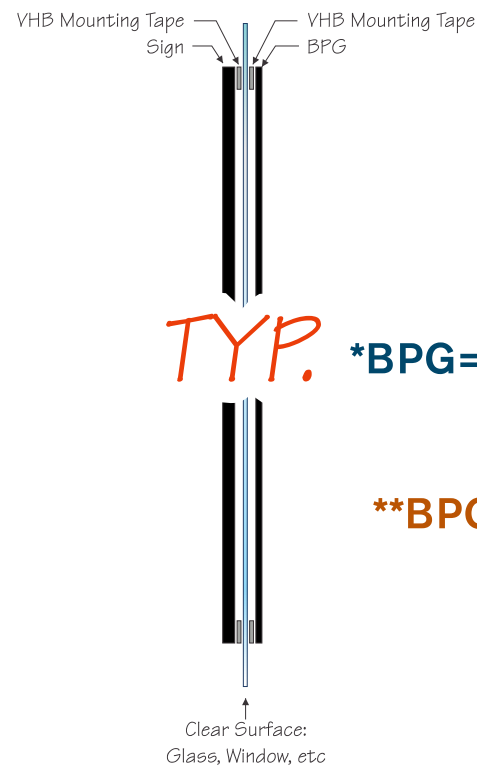
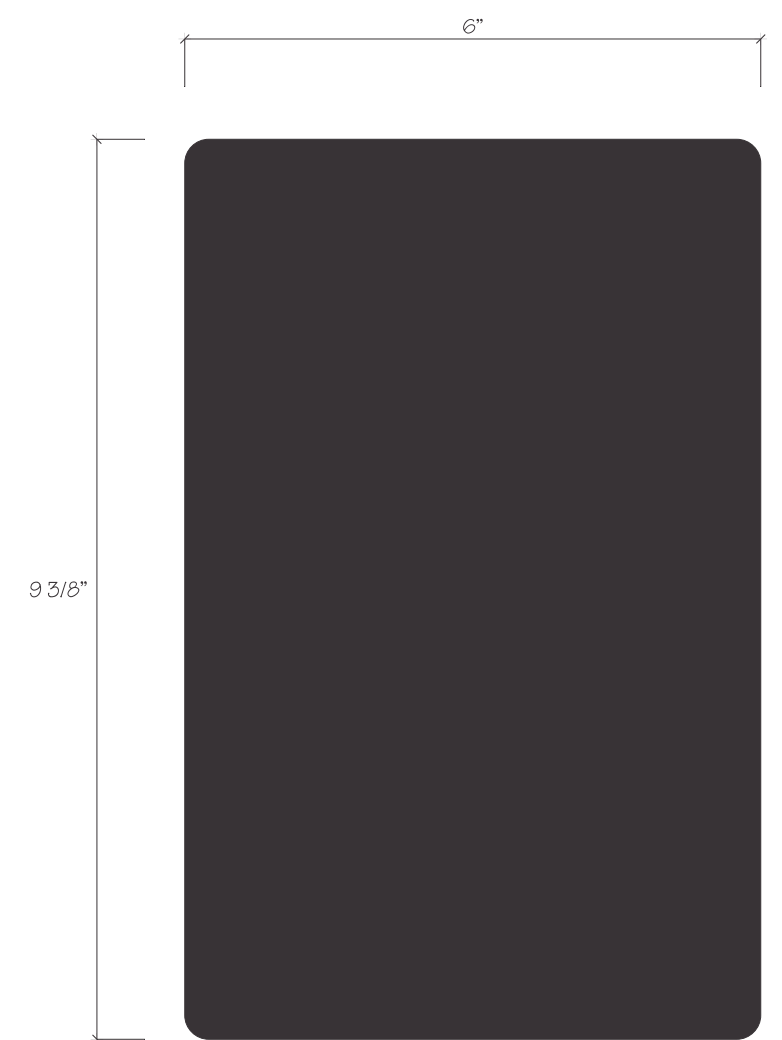

*TYP.*

**\*BPG= Backplate For Glass/Window Mounting, applied to opposite side of clear surface from sign mounting to conceal mounting method.**

**\*\*BPG C.1 can be found on pg 10**

**BPG\* C.1a**

